

Precision Pure PWS 45-75

Water Distiller



**Automatic
Commercial
Size
Convenience**

For sparkling pure water, the Precision model PWS 45-75 will give you a trouble free supply of distilled water for years. All components are made from high grade stainless steel. For long life this distiller offers a unique boiling tank drain system, plus many more features. The large 75 gallon storage tank allows you to have an ample supply of distilled water on hand at all times.



PWS 45-75 SPECIFICATIONS

Height 67½" 171.5cm Width 25½" 64.8cm
Height 89" 230.0cm Depth 21" 53.4cm
Weight 152lb 77.3kg

(including 24" tower)

Volts	Amps	Hertz	Watts
208v	24.0	50/60	5100
220v	24.0	50/60	5100
240v	24.0	50/60	5100

PRECISION
Water Systems

The Precision Pure PWS 45-75 is the most advanced water distiller on the market today. It is designed with many user-friendly features:

1. Your water distiller is connected to a water supply. The raw water is fed to the distiller through a 1/2" water line (1). This line is connected to a quick connect plumbing fitting. As the raw water enters the distiller it passes through a long life Stainless Steel solenoid valve and then directly into the boiling chamber (2).
2. After the water reaches a certain level over the heating elements (3) the distiller starts the heating cycle bringing the water to boil. The pure steam (4) rises and enters the baffle system then goes directly up to the 1" Stainless Steel tower. This tower raises the steam an additional 24" to ensure that the distilled water purity in any water supply (5).
3. As the pure steam vapour starts the downward flow to the cooling coil, the steam enters the high capacity stainless cooling system (6). After the steam is cooled it is ready to enter the charcoal filter (7), then goes directly into the storage tank.
4. The storage tank is made from #304 grade Stainless Steel to ensure that your 75 gallon capacity tank keeps the water as pure as it was when the water entered the tank. As the water fills the tank it lifts the low-level pump shut off (8). When lifted, it turns the pump power on and protects it from unnecessary burn out should the tank run out of water. As the water rises in the storage tank so does the level indicator. As the float rises (9) it raises the level indicator on the top of the tank to show you the exact level of water from empty to full at all times (10). When the distiller fills the tank, the upper float level turns the unit off (11). To keep the distillers as full as possible at all times, the unit will start itself after a few gallons of water is removed.
5. The bottom of the storage tank has a deep V bottom to ensure that all water can be removed from the storage tank through any one of three 1/2" Stainless Steel drain or supply nipples (12). When the unit is in operation, it will form impurities in the boiler. This unique boiler design is equipped with a removable 4" drain screen that prevents scale from plugging the large 1 1/4" ball valve (13) or the electric auto drain system. Other optional features include a built in pump accessory plug and auto drain accessory plug to make hook up of any option easy.

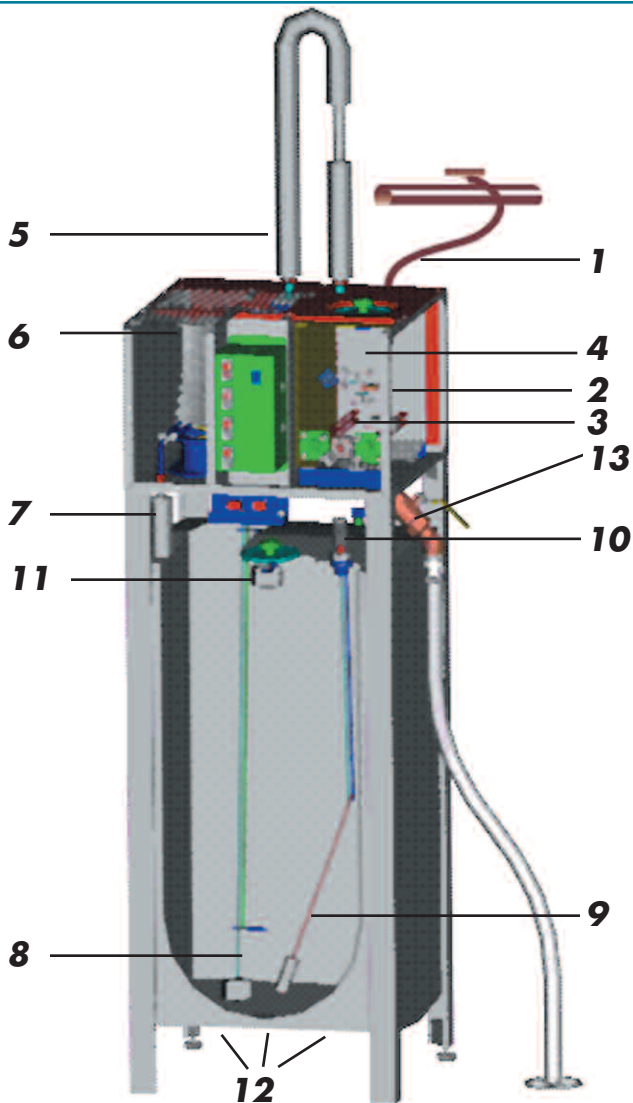

AUTOMATIC COMMERCIAL SIZE CONVENIENCE

Model PWS 45-75

Distilling Capacity: 45 US gal. (170 L)/24 hrs*









Holding Tank Capacity: 75 US gal. (284 L)

Shipping Weight: 185 lbs. (84kg)

UNIQUE FEATURES OF THE 45-75 COMMERCIAL DISTILLER

This automatic distiller will produce 45 gallons of pure water per day. Water enters the unique boiling system, rises and enters the baffle and pure water tower. The pure steam is then cooled by an efficient cooling system. After the steam is cooled it leaves the cooling coil and goes through a stainless steel tube or charcoal filter and then directly into the 75 gallon storage tank. This tank is complete with an ozone fitting and 3 pump outlet fittings. The pump kit system is plugged directly into the distiller and the pump shuts off when the water level gets close to being empty. All tanks are equipped with a leak free water sight gauge that indicates the water level at all times.

FEATURES AND BENEFITS

-  Trouble free float system
-  Sealed power switches
-  Efficient cooling coil
-  Large 5" boiling and storage tank opening
-  Plug free drain system
-  Convenient holding tank level gauge
-  100% stainless steel construction
-  Warranty- 1 year all parts and labor

FOR MORE INFORMATION ABOUT OUR PRODUCT LINE, OPTIONAL FEATURES AND OUR EXCELLENT WARRANTY, CONTACT YOUR PRECISION WATER SYSTEMS REPRESENTATIVE



10331-105 Street Westlock, Alberta,
Canada T7P 2H7

email: info@precisioncanada.com
website: www.precisioncanada.com

Manufactured by Precision Design and Manufacturing Inc. © 2000

* Note: Performance based on optimum conditions including water temperature, ambient temperature, line voltage, boiling tank cleanliness, boiler fill level, etc. * Specifications are subject to change without notice.
Printed in Canada

097046-